

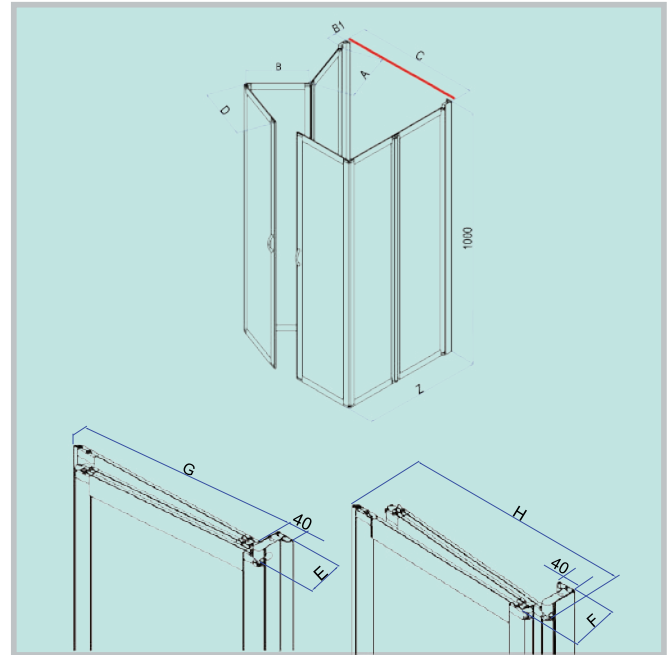







BOX8080100U - BOX9090100U

SHOWER BOX



							
REVERSIBLE OPENING FOR SIDE	EXTENSIVITY AND OUT OF SQUARE ADJUSTMENT	CUSHIONED MAGNETIC CLOSURE	DOOR LIFTING DURING OPENING-CLOSING	POLYSTYRENE PANELS	SUITABLE FOR DISABLED PEOPLE	COMBINABLE WITH FIXED WALL	GOOD WATER RESISTANCE

DESCRIPTION

Three-sided shower enclosure with folding doors both inside and outside, with 180° joints. Solutions dedicated to particular targets, for example for the elderly and disabled. Aluminum profile finish. Polystyrene panel finish. Single wall installation.

SIZE

Item	Extensibility Z [cm]	Height [cm]	A [cm]	B [cm]	B1 [cm]	C [cm]	D [cm]	E [cm]	F [cm]	G [cm]	H [cm]	I [dm ³]	J [n°]
BOX8080100U	79-83	100	36,5	34,5	6,8-10,8	80	38,5	10-14	9,5-13,5	40,5	42	63	15
BOX9090100U	87-91	100	40,5	38,5	6,8-10,8	90	43,5	10-14	9,5-13,5	45,5	47	70	18

COLOR

White

CERTIFICATIONS

ISO 9001:2015 Quality Certification issued by TÜV Italia S.r.l.

MPS reserves the right to make any changes deemed necessary to improve the products without prior notice.